

SkyLine PremiumS Electric Boiler Combi Oven 61 480V

ITEM # _____

MODEL # _____

NAME # _____

SIS # _____

AIA # _____



219740 (ECO61T310)

SKYLINE PremiumS 6 HALF SHEET PANS (13" X 18") OR 6 HOTEL PANS (12" X 20") TOUCH-ELECTRIC 480V-BOILER

Short Form Specification

Item No. _____

Combi oven with high resolution full touch screen interface, multilanguage, IPX5, ETL, EnergyStar, Ergocert

- Built-in BOILER (in s/s 316L) with Lambda Sensor
- OptiFlow: air distribution system with 7 fan speed levels
- SkyClean: Automatic and built-in self cleaning system with integrated descale of the steam generator.
- 3 Cooking modes: Automatic, Programs, Manual
- Special functions: MultiTimer cooking, Plan-n-Save, SkyHub homepage, agenda MyPlanner, SkyDuo connection to SkyLine ChillerS, automatic backup mode to avoid downtime
- USB port to download HACCP data, programs and settings. Connectivity to the cloud ready
- 6-point multi sensor core temperature probe
- Triple-glass door with double LED lights line
- Includes (3) 922062 stainless steel grids

Main Features

- Built-in steam generator: Boiler in AISI 316 steel for highly precise humidity and temperature control according to the chosen settings.
- Lambda Sensor: Real humidity control of +-1% for automatic quantity and size of food recognition to guarantee consistent cooking results
- Dry, hot convection cycle (77 °F - 575 °F/25 °C - 300 °C): ideal for convection cooking.
- Combi cycle (77 °F - 575 °F/25 °C - 300 °C): The combination of hot air and steam creating a humidity controlled cooking environment, to reduce the cooking process times and food weight loss.
- Steam cycle (77 °F - 266°F/25 °C - 130°C): Ideal for sous vide, re-thermalization, and Low Steaming of food and vegetables
- Automatic Cooking Mode: includes 9 food families (meat, poultry, fish, vegetables, pasta/rice, eggs, pastries and sweet bakery, bread, dessert) with 100+ different pre-installed variations. The Automatic Sensory Phase of the oven optimizes the cooking process according to the size, quantity and type of food loaded in the oven. Real-time monitoring of cooking parameters. Personalize and save up to 70 variations per food family.
- Cycles+: Regeneration (ideal for banqueting on plate or rethermalizing on tray)
 - Low Temperature Cooking (to minimize weight loss and maximize food quality) Patented US7750272B2 and related family
 - Proving cycle
 - EcoDelta cooking, cooking with the difference between the food probe core temperature of the food and the cooking cavity
 - Sous-vide cooking
 - Static Combi (to reproduce traditional cooking from static oven)
 - Pasteurization of pasta
 - Dehydration cycles (ideal for drying fruits, vegetables, meats, seafood)
 - Food safe Control and Advanced Food Safe Control: to automatically monitor safely the cooking process in compliance with HACCP hygienic standards or drive cooking with pasteurization factor Patented US6818865B2 and related family
- Programs mode: a maximum of 1000 recipes can be stored in the oven's memory, to recreate the exact same recipe at any time. The recipes can be group in 16 different categories to better organize the menu. 16-step cooking programs also available.
- MultiTimer: Special feature to manage up to 20 different cooking cycles at the same time in the same cavity guaranteeing even cooking results. Up to 200 MultiTimer available programs
- Reversible Fan: 7 speed fan levels from 300 to 1500 RPM with reverse rotation for optimal evenness. Fan stops in less than 5 seconds when door is opened.
- 6-point multi sensor core temperature probe for maximum precision and food safety.
- Picture Management: upload full customized images of cooking cycles or food items

APPROVAL: _____

- Automatic cool-down and pre-heat function
- Different chemical options available: solid (phosphate-free), liquid (requires optional accessory).
- GreaseOut: predisposed for integrated grease drain and collection for safer operations (dedicated base as optional accessory).
- USB port: to download HACCP data, share cooking programs and configurations. USB port also allows to plug-in sous-vide probe (optional accessory).
- Back-up mode: self-diagnosis is automatically activated if a failure occurs to avoid downtime.
- Capacity: 6 half sheet/hotel pans.
- OptiFlow air distribution system to achieve maximum performance in chilling/heating evenness and temperature control thanks to a special design of the chamber.

Construction

- Triple thermo-glazed door: with 2 hinged inside panels for easy cleaning and double LED lights line.
- Seamless hygienic internal chamber with all rounded corners for easy cleaning.
- 304 AISI stainless steel construction throughout.
- Front access to control board for easy service.
- Integrated spray gun with automatic retracting system for fast rinsing.
- IPX 5 spray water protection certification for easy cleaning.
- Supplied with 6 tray rack for hotel pans, 2 2/3" pitch (67 mm).

User Interface & Data Management

- Touchscreen: High resolution interface (translated into more than 30 languages including Spanish and French) - color-blind friendly panel.
- Make-it-mine: feature to allow full personalization or locking of the user interface by selecting what is visible on screen
- SkyHub: customizable homepage to allow the user to group their favorite functions for immediate access when operating.
- MyPlanner: on-screen agenda where the user can plan their daily work, set reminders for several users and receive personalized alerts for each activity
- SkyDuo: Oven and Blast Chiller automatic communication to guide the user through the cook&chill process by creating a safe controlled environment to optimize time and efficiency (requires optional accessory).
- Connectivity: ready for real time access to connected appliances from remote and HACCP monitoring (requires optional accessory).
- e-learning: equipment trainings, how-to guides, and technical documentation easily accessible by scanning QR-Code with any mobile device.
- Data Analytics: automatic consumption visualization at the end of the cycle.

Sustainability



- Human centered design: with 4-star certification for ergonomics and usability.
- Door handle: ergonomic wing-shaped design for hands-free door opening with elbow, to allow simple trays management (Registered Design at EPO).
- Reduced-Power Feature: To consume less energy during customized slow cooking cycles.
- SkyClean: Automatic self cleaning system with integrated descaling of the steam boiler. 5 automatic cycles (soft, medium, strong, extra strong, rinse-only) and green

functions to save energy, water, detergent and rinse aid. Also programmable with delayed start.

- Plan-n-Save: the oven organizes the sequence of the chosen cooking cycles to optimize the processes in the kitchen reducing time and energy consumption.
- Energy Star 2.0 certified product.

Included Accessories

- 3 of Single 304 stainless steel grid (12" x 20") PNC 922062

Optional Accessories

- | | | |
|---|------------|--------------------------|
| • Caster kit for base for 61, 62, 101 and 102 oven bases only | PNC 922003 | <input type="checkbox"/> |
| • Pair of half size oven racks, type 304 stainless steel | PNC 922017 | <input type="checkbox"/> |
| • Chicken racks, pair (2) (fits 8 chickens per rack) | PNC 922036 | <input type="checkbox"/> |
| • Single 304 stainless steel grid (12" x 20") | PNC 922062 | <input type="checkbox"/> |
| • Stainless steel 304 grids (GN ½) with spikes, fits 4 chickens | PNC 922086 | <input type="checkbox"/> |
| • External side spray unit | PNC 922171 | <input type="checkbox"/> |
| • Baguette tray, made of perforated aluminum, silicon coated, 16" x 24" | PNC 922189 | <input type="checkbox"/> |
| • Perforated baking tray, made of perforated aluminum, 16" x 24" | PNC 922190 | <input type="checkbox"/> |
| • Baking tray, made of aluminum 16" x 24" | PNC 922191 | <input type="checkbox"/> |
| • Pair of frying baskets | PNC 922239 | <input type="checkbox"/> |
| • Pastry grid 16" x 24" | PNC 922264 | <input type="checkbox"/> |
| • Double-click closing catch for oven door | PNC 922265 | <input type="checkbox"/> |
| • Grid for whole chicken 1/1GN (8 per grid - 2.6 lbs each) | PNC 922266 | <input type="checkbox"/> |
| • USB Probe for sous-vide cooking (only for Touchline ovens) | PNC 922281 | <input type="checkbox"/> |
| • Grease collection tray (4") for 61 and 101 ovens | PNC 922321 | <input type="checkbox"/> |
| • Kit universal skewer rack & (4) long skewer ovens (TANDOOR) | PNC 922324 | <input type="checkbox"/> |
| • Universal skewer pan for ovens (TANDOOR) | PNC 922326 | <input type="checkbox"/> |
| • Skewers for ovens, (4) 24" long (TANDOOR) | PNC 922327 | <input type="checkbox"/> |
| • Smoker for ovens | PNC 922338 | <input type="checkbox"/> |
| • Multipurpose hook | PNC 922348 | <input type="checkbox"/> |
| • 4 FLANGED FEET FOR 61,62,101,102 OVENS - 2" 100-130MM | PNC 922351 | <input type="checkbox"/> |
| • Grid for 8 whole ducks (1.8KG, 4LBS) - GN 1/1 | PNC 922362 | <input type="checkbox"/> |
| • HOLDER FOR DETERGENT TANK - WALL MOUNTED | PNC 922386 | <input type="checkbox"/> |
| • USB SINGLE POINT PROBE | PNC 922390 | <input type="checkbox"/> |
| • 6 Tray Rack with wheels, Half Sheet Pans, 2 ½" (65mm) pitch for 61 ovens and blast chillers | PNC 922600 | <input type="checkbox"/> |
| • 5 Tray Rack with wheels, Half Sheet Pans, 3" (80mm) pitch, for 61 ovens and blast chillers | PNC 922606 | <input type="checkbox"/> |
| • Bakery/pastry tray rack with wheels 400x600mm for 6 GN 1/1 oven and blast chiller freezer, 80mm pitch (5 runners) | PNC 922607 | <input type="checkbox"/> |

• Slide-in rack with handle for 61 and 101 combi oven	PNC 922610	<input type="checkbox"/>	• Mesh grilling grid (12" x 20")	PNC 922713	<input type="checkbox"/>
• Open base with tray support for 61 & 101 combi oven	PNC 922612	<input type="checkbox"/>	• Probe holder for liquids	PNC 922714	<input type="checkbox"/>
• Cupboard base with tray support for 61 & 101 combi oven	PNC 922614	<input type="checkbox"/>	• Fixed tray rack, 61 combi oven, h=85mm (3 1/3")	PNC 922740	<input type="checkbox"/>
• HOT CUPBOARD BASE WITH TRAY SUPPORT FOR 61 AND 101 OVEN HALF SHEET PANS (12" X 20")	PNC 922615	<input type="checkbox"/>	• 4 high adjustable feet for 61,62 & 101,102 combi ovens, 230-290mm (9in - 11 2/5in)	PNC 922745	<input type="checkbox"/>
• External connection kit for detergent and rinse aid	PNC 922618	<input type="checkbox"/>	• Tray for traditional static cooking, H=100mm (12" x 20")	PNC 922746	<input type="checkbox"/>
• Grease collection kit for 61,62,101,102 cupboard base (trolley with 2 tanks, open/close device and drain)	PNC 922619	<input type="checkbox"/>	• Double-face griddle, one side ribbed and one side smooth, 400x600mm	PNC 922747	<input type="checkbox"/>
• Stacking kit for electric 61/61 combi ovens or electric 61/101 combi ovens	PNC 922620	<input type="checkbox"/>	• TROLLEY FOR GREASE COLLECTION KIT	PNC 922752	<input type="checkbox"/>
• Trolley for slide-in rack for 61 and 101 combi oven and blast chiller freezer	PNC 922626	<input type="checkbox"/>	• WATER INLET PRESSURE REDUCER	PNC 922773	<input type="checkbox"/>
• Trolley for mobile rack for 2 stacked 61 combi ovens on riser	PNC 922628	<input type="checkbox"/>	• KIT FOR INSTALLATION OF ELECTRIC POWER PEAK MANAGEMENT SYSTEM-6-10 GN OVENS	PNC 922774	<input type="checkbox"/>
• Trolley for mobile rack for 61 on 61 or 101 combi ovens	PNC 922630	<input type="checkbox"/>	• Extension for condensation tube, 37cm	PNC 922776	<input type="checkbox"/>
• RISER ON FEET FOR STACKED 2X6 GN 1/1 OVENS OR 6 GN 1/1 OVEN ON BASE	PNC 922632	<input type="checkbox"/>	• Non-stick universal pan (12" x 20" x 3/4")	PNC 925000	<input type="checkbox"/>
• Riser on wheels for 2 stacked 61 combi ovens, height=250mm (9 6/7in)	PNC 922635	<input type="checkbox"/>	• Non-stick universal pan (12" x 20" x 1 1/2")	PNC 925001	<input type="checkbox"/>
• Stainless steel drain kit for all oven sizes (61, 62, 101,102, 201,202)-dia=50mm (2")	PNC 922636	<input type="checkbox"/>	• Non-stick universal pan (12" x 20" x 2 1/2")	PNC 925002	<input type="checkbox"/>
• Plastic drain kit for all oven sizes (61, 62, 101,102,201, 202), dia=50mm (2")	PNC 922637	<input type="checkbox"/>	• Frying griddle double sided (ribbed/smooth) 12" x 20"	PNC 925003	<input type="checkbox"/>
• Trolley with 2 tanks for grease collection	PNC 922638	<input type="checkbox"/>	• Aluminum combi oven grill (12" x 20")	PNC 925004	<input type="checkbox"/>
• Grease collection kit for open base (2 tanks, open/close device and drain)	PNC 922639	<input type="checkbox"/>	• Egg fryer for 8 eggs (12" X 20")	PNC 925005	<input type="checkbox"/>
• Wall support for 61 oven	PNC 922643	<input type="checkbox"/>	• Flat baking tray with 2 edges (12" x 20")	PNC 925006	<input type="checkbox"/>
• Dehydration tray, (12" x 20"), H=2/3"	PNC 922651	<input type="checkbox"/>	• Baking tray for (4) baguettes (12" x 20")	PNC 925007	<input type="checkbox"/>
• Flat dehydration tray, (12" x 20")	PNC 922652	<input type="checkbox"/>	• Potato baker GN 1/1 for 28 potatoes (12"X20")	PNC 925008	<input type="checkbox"/>
• Bakery/pastry rack kit for 6 GN 1/1 oven with 5 racks 400x600mm and 80mm pitch	PNC 922655	<input type="checkbox"/>	• Non-stick U-pan (12" x 10" x 3/4")	PNC 925009	<input type="checkbox"/>
• Stacking kit for gas 6 GN 1/1 oven placed on 7kg and 15kg crosswise blast chiller freezer	PNC 922657	<input type="checkbox"/>	• Non-stick U-pan (12" x 10" x 1 1/2")	PNC 925010	<input type="checkbox"/>
• Heat shield for stacked ovens 61 on 61 combi ovens	PNC 922660	<input type="checkbox"/>	• Non-stick U-pan (12" x 10" x 2 1/2")	PNC 925011	<input type="checkbox"/>
• Heat shield for stacked ovens 61 on 101 combi ovens	PNC 922661	<input type="checkbox"/>	• Compatibility kit for installation on previous base 61,101	PNC 930217	<input type="checkbox"/>
• Heat shield for 61 combi oven	PNC 922662	<input type="checkbox"/>			
• Compatibility kit for installation of 61 Skyline electric combi oven on previous generation 61 electric combi oven	PNC 922679	<input type="checkbox"/>			
• Fixed tray rack for 6 GN 1/1 and 400x600mm grids	PNC 922684	<input type="checkbox"/>			
• Kit to fix oven to the wall	PNC 922687	<input type="checkbox"/>			
• Tray support for 61 & 101 oven base	PNC 922690	<input type="checkbox"/>			
• 4 adjustable feet with black cover for 61,62 & 101,102 combi ovens, 150-200mm (5 9/10in -7 9/1in)	PNC 922693	<input type="checkbox"/>			
• Detergent tank holder for open base	PNC 922699	<input type="checkbox"/>			
• Bakery/pastry runners 400x600mm for 6 & 10 GN 1/1 oven base	PNC 922702	<input type="checkbox"/>			
• Wheels for stacked ovens	PNC 922704	<input type="checkbox"/>			

Front

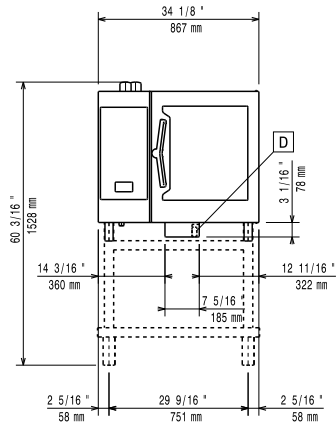

Side

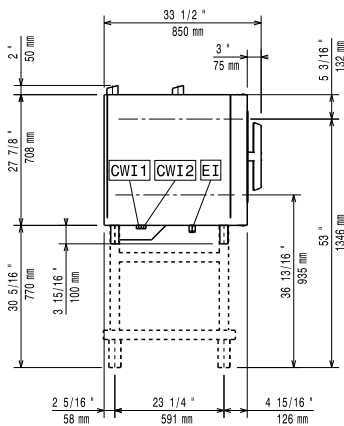

CWI1 = Cold Water inlet EI = Electrical connection

CWI2 = Cold Water Inlet 2

D = Drain

DO = Overflow drain pipe

Top

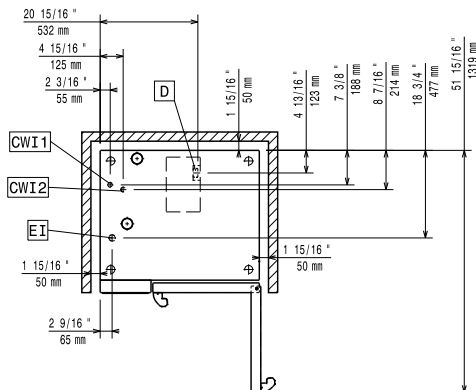

Electric

Supply voltage:

219740 (ECO61T310) 480 V/3 ph/60 Hz

Electrical power, default:

11.1 kW

Electrical power, max:

11.1 kW

Water:

Water Cold Supply

Connection: 3/4"

Cold Water Inlet Connection: 3/4" GHT

Max inlet water supply temperature: 86°F (30°C)

Drain "D": 2" (50 mm)

Pressure: 15-87 psi (1-6 bar)

Chlorides: <85 ppm

Conductivity: 0 µS/cm

Water inlet cold 1: unfiltered

Water inlet cold 2: filtered

Electrolux Professional recommends the use of treated water, based on testing of specific water conditions. Refer to manual for details

Installation:

Clearance:

Clearance: 2 in (5 cm) rear and right hand sides.

Suggested clearance for service access:

20 in (50 cm) left hand side.

Capacity:

Max load capacity: 66 lbs (30 kg)

Hotel pans: 6 - 12" X 20"

Half-size sheet pans: 6 - 13" X 18"

Key Information:

Door hinges:

External dimensions, Width: 34 1/8" (867 mm)

External dimensions, Depth: 30 1/2" (775 mm)

External dimensions, Height: 31 13/16" (808 mm)

Net weight: 277 lbs (125.5 kg)

Shipping width: 36 5/8" (930 mm)

Shipping depth: 36 5/8" (930 mm)

Shipping height: 40 9/16" (1030 mm)

Shipping weight: 314 lbs (142.5 kg)

Shipping volume: 31.46 ft³ (0.89 m³)

ISO Certificates

ISO Standards:

ISO 9001; ISO 14001; ISO 45001; ISO 50001

Sustainability

Current consumption:

13.8 Amps